

Instruction Manual

Active Digital Controller



Description	Item Number
Active Digital Controller - Standard Version	D395-90-000
Active Digital Controller - Enhanced Version	D395-91-500





Declaration of Conformity

We, Edwards,
Crawley Business Quarter,
Manor Royal,
Crawley,
West Sussex, RH10 9LW, UK

declare under our sole responsibility, as manufacturer and person within the EU authorised to assemble the technical file, that the product(s)

Active Digital Controller - Standard version	D395-90-000
Active Digital Controller - Enhanced version	D395-91-500

to which this declaration relates is in conformity with the following standard(s) or other normative document(s)

EN61010-1: 2001	Safety Requirements for Electrical Equipment for Measurement, Control and Laboratory Use. General Requirements
EN 61326-1: 2006 (Class B Emissions)	Electrical equipment for measurement, control and laboratory Use. EMC requirements. General requirements
EN50581:2012	Technical Documentation for the Assessment of Electrical and Electronic Products with respect to the Restriction of Hazardous Substances

Following the provisions of

2006/95/EC	Low Voltage Directive
2004/108/EC	Electromagnetic Compatibility (EMC) Directive
2011/65/EU*	Restriction of Certain Hazardous Substances (RoHS) Directive

** i. e. The product(s) contain less than - 0.1wt% for hexavalent chromium, lead, mercury, PBB and PBDE; 0.01wt% for cadmium - in homogeneous materials (subject to the exemptions allowed by the Directive). The RoHS Directive does not legally apply to industrial vacuum equipment until July 2019 (July 2017 for instruments).*

Note: This declaration covers all product serial numbers from the date this Declaration was signed onwards.

Mr L Marini, Senior Technical Manager

14.03.2013, Eastbourne

Date and Place

This product has been manufactured under a quality system registered to ISO9001

Contents

Section	Page
1	Introduction 1
1.1	Scope and definitions 1
1.2	Product description 1
2	Technical data 3
2.1	Electrical data 3
2.2	Operating and storage data 3
2.3	Mechanical data 3
2.4	Display 3
2.5	Connections 4
2.5.1	Active gauge connectors 4
2.5.2	Analogue / relay connector (enhanced only) 5
2.5.3	Serial communications (enhanced only) 6
3	INSTALLATION 7
3.1	Unpack and inspect 7
3.2	Fitting the controller 7
3.2.1	Bench-top mounting 7
3.2.2	Panel mounting 8
3.3	Rear panel description 9
3.3.1	Connecting the electrical supply 9
3.3.2	Connecting active gauges 9
3.3.3	Connecting the analogue / relay connector (enhanced only) 10
3.3.4	Connecting the serial interface (enhanced only) 10
4	OPERATION 11
4.1	Front panel description 11
4.2	Power up 11
4.2.1	Return to Factory Defaults 11
4.3	Gauge identification 12
4.4	Gauge display (standard) 12
4.5	Menu structure (enhanced) 13
4.5.1	Gauge pressure display 13
4.5.2	Set-point and link threshold adjustment 13
4.5.3	Set-point 2 controlling gauge 14
4.5.4	Gauge calibration 14
4.5.5	Units selection 14
4.6	RS232 operation (enhanced only) 15
4.6.1	Message basics 15
4.6.2	Commands 15
4.6.3	Queries 15
4.6.4	Responses 16
4.7	Linking two ADCs (enhanced only) 16
4.7.1	Using two ADCs 16
4.7.2	Using one ADC 16
5	MAINTENANCE 17
5.1	Safety 17
5.2	Fault finding guide 17
5.3	Cleaning the controller 18

5.4	Software upgrade	18
5.5	Calibration service	18
6	STORAGE AND DISPOSAL	19
6.1	Storage	19
6.2	Disposal	19
7	SPARES AND ACCESSORIES	21
7.1	Introduction	21
7.2	Accessories	21
Appendix A	Error Numbers	23
Appendix B	RS232 Commands	25
Appendix C	RS232 Queries	27
	Index	29

For return of equipment, complete the HS Forms at the end of this manual.

Illustrations

Figure		Page
1	Pin connections for an 8-way FCC/RJ45	4
2	Pin connections and pin-out for the analogue / relay connector	5
3	Pin connections for the serial comms connector	6
4	Bench mounted dimensions (mm)	7
5	Panel cut-out required	8
6	Panel mounting the ADC	8
7	Rear panel connections	9
8	IBM PC RS232 interface - 9-way	10
9	IBM PC RS232 interface - 25-way	10
10	Front panel displays	11

Tables

Table		Page
1	Compatible gauges for the ADC	1
2	Gauge connector pin-out	4
3	Pin connections and pin-out for the analogue / relay connector	5
4	Pin connections for the serial comms connector	6
5	Component checklist	7
6	Front panel symbols and their functions	11
7	Gauge ID numbers	12
8	Menu items	13
9	RS232 commands	15
10	RS232 queries	16
11	Fault finding guide	17
12	Accessories	21
A1	ADC error numbers	23

Trademark credits

Barocel™ is a registered trademark of Edwards.

This page has been intentionally left blank.

1 Introduction

1.1 Scope and definitions

This manual provides installation, operation and maintenance instructions for the Edwards Active Digital Controller. You must use the Controller as specified in this manual. Read this manual before you install and operate the Edwards Active Digital Controller. Important safety information is highlighted as WARNING and CAUTION instructions; you must obey these instructions. The use of WARNINGS and CAUTIONS is defined below.



WARNING

Warnings are given where failure to observe the instruction could result in injury or death to people.

CAUTION

Cautions are given where failure to observe the instruction could result in damage to the equipment, associated equipment and process.

The following IEC warning label appears on the Active Digital Controller:



Warning - refer to accompanying documentation.



From August 2005, Edwards will offer European customers a recycling service.

1.2 Product description



WARNING

Improper use of the equipment could cause damage to it or injury to people. The user is responsible for the safe operation and maintenance of the equipment.

The ADC (Active Digital Controller) is used for displaying pressures measured by Edwards Active Gauges. The ADC is available in two versions. The Standard version provides a large clear LED display for a single gauge, and the Enhanced version has additional features: 2 gauge inputs, 2 set-point relays, analogue outputs for data recording and an RS232 interface for control and data monitoring on a remote PC.

Throughout this manual, certain sections are applicable only to the Standard or Enhanced versions. These sections are marked "Standard only" or "Enhanced only". The compatible gauges that can be used with the Active Digital Controller are listed in [Table 1](#).

Table 1 - Compatible gauges for the ADC

ADC version	Compatible gauges
Standard	APG100-XM, APG100-XLC, APG-L, APG-M, APG-MP, APGX-H, APGX-L, APGX-M, APGX-MP and WRG
Enhanced	As above, plus AIM-S, AIM-X and ASG

This page has been intentionally left blank.

2 Technical data

2.1 Electrical data

Connector type	CEE/IEC 320
Electrical supply	100 to 240 V a.c. 47 to 63 Hz
Power consumption	15 W maximum
Peak inrush current	20 A at 110 V a.c. 40 A at 240 V a.c.
Fuse	The unit is protected by an internal fuse. This fuse is not user replaceable.

2.2 Operating and storage data

Ambient operating temperature range	0 °C to 40 °C
Ambient storage temperature range	-30 °C to 70 °C
Maximum ambient operating humidity	Max 90% RH non condensing at 40 °C
Maximum operating altitude	2000 m max
IP rating	IP20. IP40 when panel mounted. For indoor use only.

2.3 Mechanical data

Mass	0.33 kg
Dimensions (w x h x d)	96 x 48 x 165 mm
Panel cut-out	92 ^{+0.8} x 45 ^{+0.6} mm to DIN43700
Panel thickness	1.5 mm minimum

2.4 Display

Type	High brightness green LED 7-segment display LED enunciators for units and display mode
Update rate	300 ms

2.5 Connections

2.5.1 Active gauge connectors

Connector type	RJ45, 8-way (refer to Figure 1)
Power supply	24 V d.c. nominal
Maximum power rating	4 W total

Figure 1 - Pin connections for an 8-way FCC/RJ45

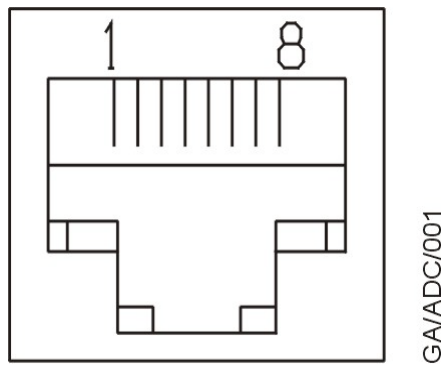

Table 2 - Gauge connector pin-out

Pin	Allocation
1	Power supply positive
2	Power supply common
3	Signal input
4	Identification
5	Signal common
6	Control line 1
7	Control line 2
8	N/C

2.5.2 Analogue / relay connector (enhanced only)

Connector type	9-way sub-miniature 'D' type plug (refer to Figure 2)
Relays:	
Relay type	Volt-free single pole change-over
Relay voltage	48 V max
Relay current	1A @ 48 V d.c. 2A @ 24 V d.c.
Analogue outputs:	
Output voltage	0 to 10 V
Minimum load impedance	10 k Ω
Maximum current	1 mA
Accuracy	$\pm 2\% \pm 10$ mV

Figure 2 - Pin connections and pin-out for the analogue / relay connector

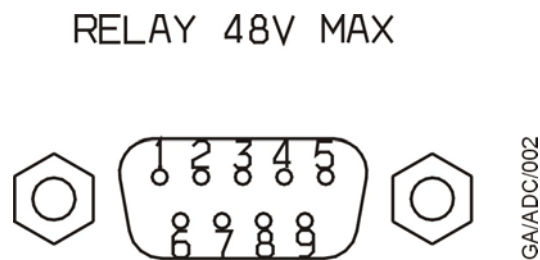

Table 3 - Pin connections and pin-out for the analogue / relay connector

Pin	Allocation
1	Analogue output common
2	Analogue output signal 1
3	Relay 2 common
4	Relay 1 normally - Closed
5	Relay 1 normally - Open
6	Analogue output signal 2
7	Relay 2 normally - Closed
8	Relay 2 normally - Open
9	Relay 1 common

2.5.3 Serial communications (enhanced only)

Connector type	9-way sub-miniature 'D' type socket (refer to Figure 3)
RS232 transmit	mark: < -5 V (I_{out} max: -1.5 mA) space: > +5 V (I_{out} max: +1.5 mA)
RS232 receive	mark: < +0.8 V space: > +2.4 V input resistance: 5 k Ω
Maximum input	± 25 V
RS232 protocol	9600 baud, 1 stop bit, 8 data bits, no parity
Maximum cable length	10 m
Message rate	3 per second maximum

Figure 3 - Pin connections for the serial comms connector

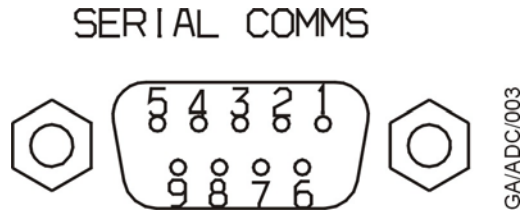

Table 4 - Pin connections for the serial comms connector

Pin	Allocation
1	N/C
2	RS232 transmit
3	RS232 received
4	N/C
5	RS232 common
6	N/C
7	N/C
8	N/C
9	N/C

3 INSTALLATION

3.1 Unpack and inspect

Remove all of the packaging material and check the ADC. If the Controller is damaged, follow the Edwards return of equipment procedures that are laid out in the back of this manual. Do not use the Controller if it is damaged.

Check that your package contains the items that are listed in Table 5. If any of these items are missing, notify your supplier in writing within three days. If the Controller is not to be used immediately, store the Controller in suitable conditions as described in Section 6.1.

Table 5 - Component checklist

Quantity	Description	Check (✓)
1	Active Digital Controller	<input type="checkbox"/>
2	Panel mounting clamps	<input type="checkbox"/>
4	Non-slip feet	<input type="checkbox"/>

3.2 Fitting the controller



WARNING

Ensure that all wiring is safely secured so that people cannot trip on them.

CAUTION

Ensure that the unit is installed where fluids cannot enter into the Controller. The Controller is IP20 rated, and therefore has no protection against fluid ingress.

3.2.1 Bench-top mounting

The ADC can be used on a bench-top. Figure 4 shows the dimensions of the Controller that are required for bench top use. The self-adhesive non-slip feet may be fitted to the bottom of the Controller if required.

Figure 4 - Bench mounted dimensions (mm)

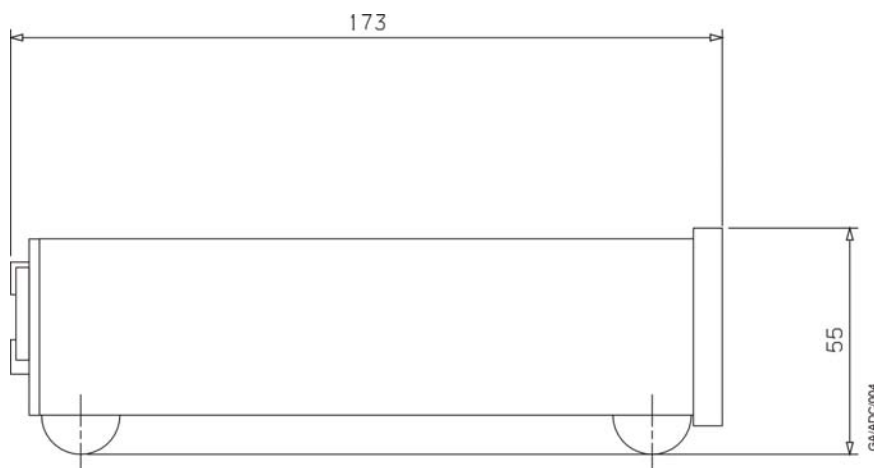

3.2.2 Panel mounting

If the Controller is to be panel mounted, follow the directions given in Figure 5 and Figure 6 below.

CAUTION

Allow 150 mm at the rear for cables. Allow 50 mm top and bottom and 15 mm to the sides for sufficient air circulation.

Figure 5 - Panel cut-out required

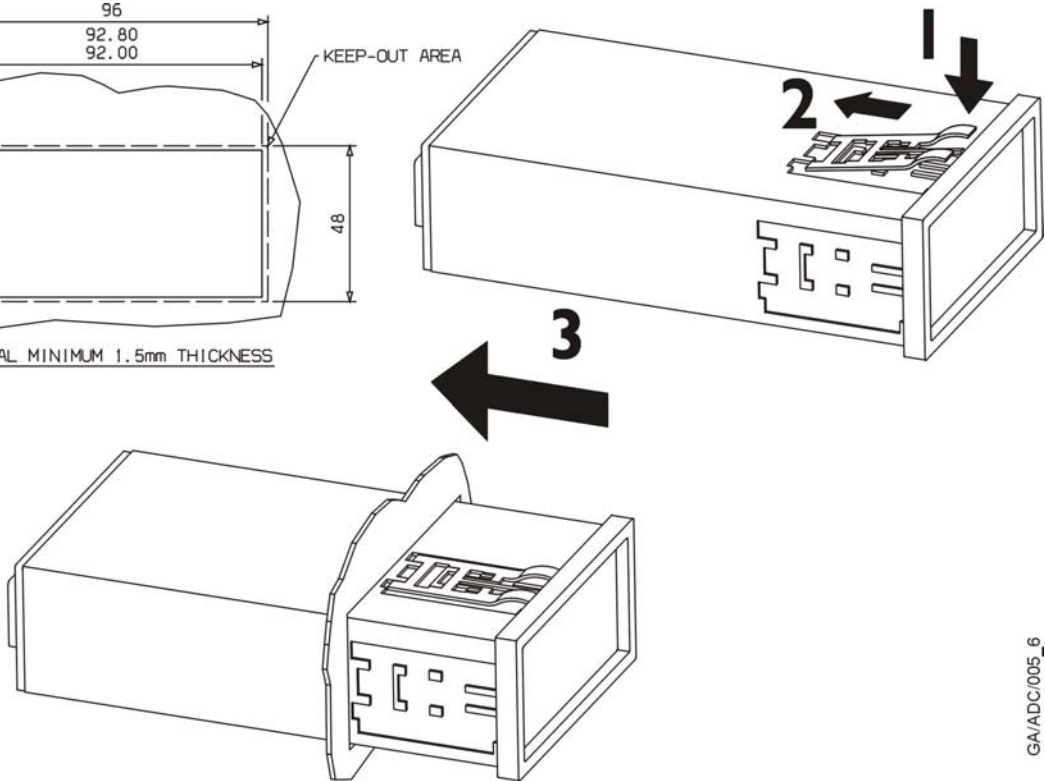
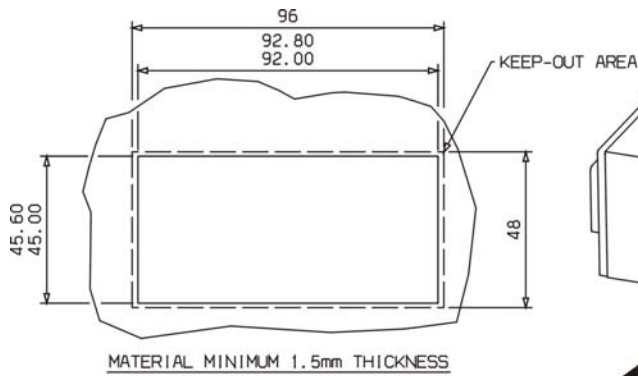

GA/ADC/005_6

Figure 6 - Panel mounting the ADC

- Make a cut-out in the panel according to Figure 5. The minimum panel thickness should be 1.5 mm.
- Fit the panel mount clamps to the case, by placing into the recesses and sliding towards the rear of the case. Use both the left and right or the top and bottom mounting positions.
- Slide the Controller into the panel from the front. The Controller is a push fit and will be retained by the spring clamps.

3.3 Rear panel description

Figure 7 - Rear panel connections

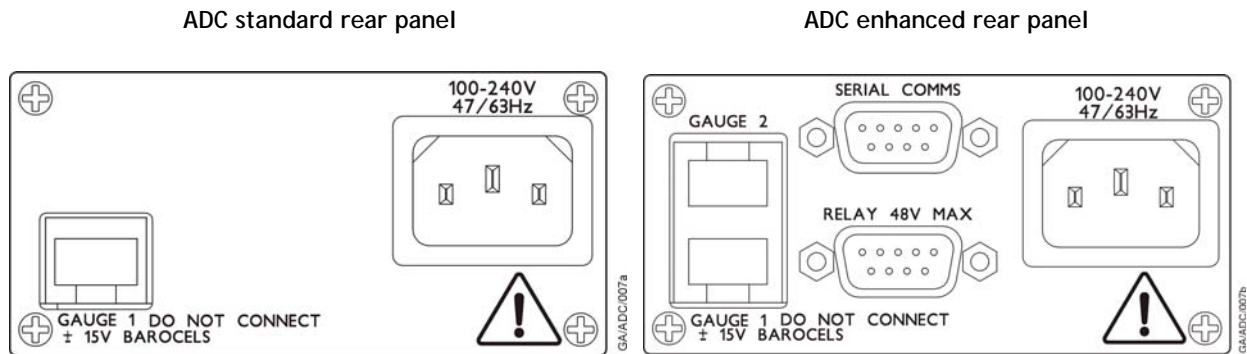

3.3.1 Connecting the electrical supply



WARNING

Ensure that the Controller is earthed (grounded) via the electrical supply cable and observe all appropriate safety precautions for the safe installation and handling of electrical equipment. High voltages exist in the Controller when it is operating.



WARNING

If access to the IEC connector is restricted an additional isolation device should be provided, that will be easily accessible by an operator.

Connect the electrical supply to the Controller with an appropriate supply cable fitted with an IEC plug. Suitable cables are available from Edwards.

3.3.2 Connecting active gauges

CAUTION

Do not connect Barocel™ capacitance manometers to the ADC. Doing so will result in damage to the gauge and will invalidate the warranty.

One or two (depending on version) compatible Active Gauges can be connected to the gauge connectors on the rear panel. Connect the gauges using Edwards Active Gauge cables. These are available ready-made in different lengths, see Section 7.2.

3.3.3 Connecting the analogue / relay connector (enhanced only)

The analogue / relay connector provides two relays for control of your own equipment, and analogue outputs which can be used for recording the gauge signals.

3.3.3.1 Using relays



WARNING

Do not connect the relays to voltages greater than 48 V d.c.
Do not use the relay outputs for safety purposes.

The two relays are volt-free single pole change-over types. Relay 1 is controlled by gauge 1, and relay 2 is controlled by gauge 1 or gauge 2. The relays are energised when the indicated pressure of the relevant gauge falls below the set-point low threshold, and de-energised when the pressure rises above the set-point high threshold. The threshold values are independently set using the front panel keys (see Section 4.5.3). The LED indicators on the front panel are lit when the relays are energised.

3.3.3.2 Using analogue outputs

Two analogue outputs provide the gauge signal voltage for monitoring or recording purposes. These can be connected to a chart recorder or other similar equipment. The outputs are buffered to prevent disturbance of the gauge signal, and will follow the gauge signal to within the accuracy specified in Section 2.5.2.

3.3.4 Connecting the serial interface (enhanced only)

The ADC has an RS232 interface built in, which allows a host PC to control the ADC.

The ADC is fitted with a 9-way 'D' type socket on the rear panel. The interface uses two lines for data transfers and an additional line as a signal common. Hardware handshaking is not implemented.

If connecting to an IBM compatible PC fitted with a 9-way 'D' type socket then a 'straight through' male-female 9-way extension cable can be used to connect the ADC to the computer as shown in Figure 8. Connection to an IBM PC fitted with a 25-way serial connector should be made as shown in Figure 9.

Use shielded cable for the interface to reduce interference problems and limit the length of the RS232 link to less than 10 metres. For longer links, install line drivers.

Figure 8 - IBM PC RS232 interface - 9-way

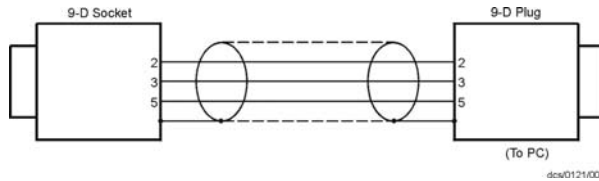
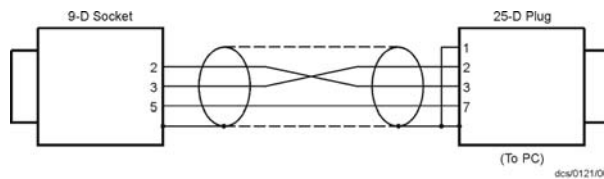

Figure 9 - IBM PC RS232 interface - 25-way



4 OPERATION

4.1 Front panel description

Figure 10 - Front panel displays

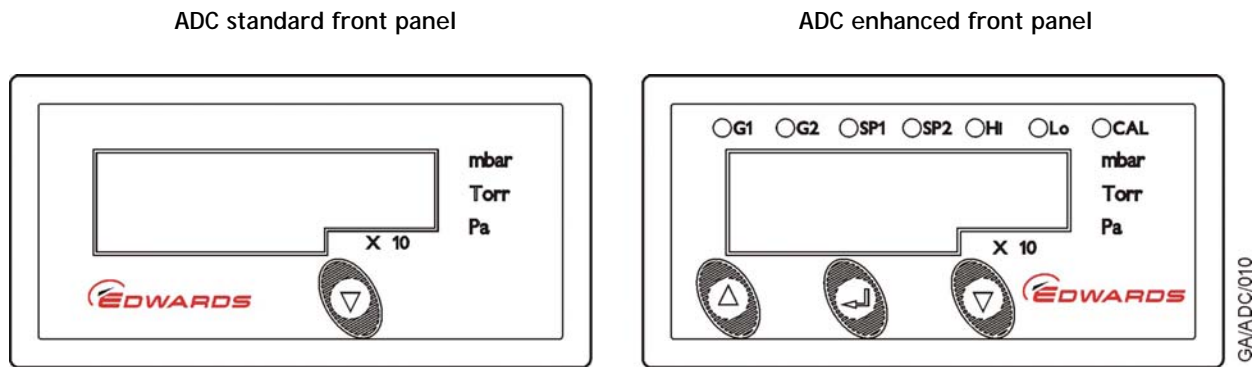

Table 6 - Front panel symbols and their functions

Symbol	Name	Function
△	UP	Move to previous selection. Cycle selected numerical values up.
▽	DOWN	Move to next selection. Cycle selected numerical values down.
↵	ENTER	Turn the selected gauge on or off. Edit the selected numerical item. Move to the next digit of a numerical value.

4.2 Power up

When you apply power to the ADC, all LEDs in the display will light for 2 seconds to confirm operation. The software version will then be displayed for a further 2 seconds, in the format "AdCxx". If you need to contact Edwards for support regarding the ADC, please have this software version number available.

4.2.1 Return to Factory Defaults

The ADC can be reset to factory defaults by holding the "UP" key before you apply power to the ADC, and continuing to hold it throughout the startup process. The startup screens will be displayed and then "Err01" will be shown to confirm successful reset. Disconnect all connected gauges and power cycle to clear this message.

4.3 Gauge identification

When a gauge is connected to the ADC, the display mode will change to display the reading from that gauge. An identification message consisting of "ID" followed by a number will be displayed for 3 seconds to show that the ADC has identified the new gauge. The ID numbers and corresponding gauges are shown in [Table 7](#).

Table 7 - Gauge ID numbers

ID number	Gauge
ID 04	APG-M / APG-MP
ID 05	APG-L
ID 06	APGX-H
ID 11	AIM-S
ID 15	ASG
ID 19	AIM-X
ID 20	WRG
ID 21	APGX-L / APGX-M / APGX-MP / APG100-XM / APG100-XLC

If a gauge cannot be identified or is of a type which is not supported by the Controller, then the message "???" will be displayed.

Where an ASG is used, you need to select the full-scale range of the gauge. This can only be done when the gauge is first connected. After the identification message "ID15", the display will show 1.0³, representing a 1000 mbar ASG. You can change this to 2.0³ for a 2000 mbar ASG using the UP and DOWN keys (Δ/∇). When the required value is showing on the display, press the ENTER key ($\leftarrow\lrcorner$).

4.4 Gauge display (standard)

The ADC will continuously display the pressure measured by an Active Gauge. The display is in exponential format. The pressure units are shown by the LEDs on the right of the display. Use the DOWN key (∇) to change the pressure units. The units mbar, Torr and Pascal will be selected in turn. A further press of the DOWN key (∇) will select voltage mode, in which the output voltage of the Active Gauge will be displayed, and the LED enunciators will extinguish. To return to pressure display, press the DOWN key (∇) again.

If an error condition is detected by the gauge or by the controller, then the display will show an error message of the form "Err" followed by a number. Refer to [Appendix A](#) for a list of error numbers and suggested remedies. To clear the error message from the display press the DOWN key (∇). If the error originated in a gauge it may be necessary to disconnect the gauge and correct the fault before the error message can be cleared.

If a gauge is not connected then the display will show "- - -".

4.5 Menu structure (enhanced)

The LEDs along the top of the ADC indicate which item is currently being shown on the numeric display. To select the next item press the DOWN key (▾), and to select the previous item press the UP key (▴). The available items are listed in order in [Table 8](#).

Table 8 - Menu items

Gauge 1 pressure display
Gauge 2 pressure display
Set-point 1 high threshold
Set-point 1 low threshold
Set-point 2 high threshold
Set-point 2 low threshold
Set-point 2 controlling gauge
G1-G2 link high threshold
G1-G2 link low threshold
Gauge 1 calibrate
Gauge 2 calibrate
Units select

4.5.1 Gauge pressure display

When gauge 1 is selected (G1 LED lit) the pressure measured by gauge 1 is displayed. The display is in exponential format. The units are shown by the LEDs on the right of the display. If gauge 1 is a controllable gauge (for example an AIM gauge), then you can turn it on and off by pressing the ENTER key (↵). Controllable gauges default to off, and the display shows "OFF". When the gauge is turned on the display will show "Str" whilst the gauge is starting up, and will then display pressure.

When gauge 2 is selected (G2 LED lit) gauge 2 is displayed and can be controlled similarly.

If either gauge 1 or gauge 2 is displayed, the status of the set-point relays is indicated by the SP1 and SP2 LEDs. The relays are energised and the LEDs are lit when the measured pressure is below the set-point threshold.

If an error condition is detected by the gauge or by the controller, then the display will show an error message of the form "Err" followed by a number. Refer to [Appendix A](#) for a list of error numbers and suggested remedies. To clear the error message from the display press the ENTER key (↵). If the error originated in a gauge it may be necessary to disconnect the gauge and correct the fault before the error message can be cleared.

If a gauge is not connected then the display will show "- - -".

4.5.2 Set-point and link threshold adjustment

The set-point and link thresholds are adjusted using the front panel keys. Thresholds are entered and displayed as pressures, using the currently selected units.

To make an adjustment, first select the required threshold using the UP and DOWN keys (▴ / ▾). The LEDs are lit in combination to show which threshold is selected. For example: if SP1 and Hi LEDs are lit together, then the display is showing the set-point 1 high threshold. If G1, G2 and Hi LEDs are lit together, then the display is showing the link high threshold.

To change the value press the ENTER key (↵). The first digit on the display will flash and can be changed using the UP and DOWN keys (▴ / ▾). When you have selected the required value, press the ENTER key (↵) again to select the next digit. Repeat this process for the second digit and then the exponent. Note that the complete exponent is





adjusted as one number from -10 to +6. When the ENTER key () is pressed after adjusting the exponent, the complete number will be entered and the new threshold will become effective.

For each set-point, or link threshold, the low threshold must always be lower than or equal to the high threshold. If you enter a low threshold which is higher than the high threshold (or vice versa), then both thresholds will be set to the value that you have just entered.



If you set the high and low thresholds to the same value then there will be no hysteresis, and the relay may switch on and off several times as the pressure changes through the set-point threshold. It is recommended that some hysteresis is always used.

Note: *The set-point or link thresholds can be set to any value in the range 1.0×10^{-10} to 9.9×10^6 . If you set the thresholds to a pressure which cannot be measured by the gauge which you are using, then the set-points or link will not operate.*

4.5.3 Set-point 2 controlling gauge

The set-point 2 relay can be controlled by gauge 1 or gauge 2. To select which gauge is controlling the relay, first select the menu option using the UP and DOWN keys ( / ). When this option is selected, the numeric display will be blank and the SP2 LED will be lit. Either the G1 or G2 LED will flash to show the currently selected controlling gauge. To change between gauge 1 and gauge 2, press the ENTER key (). When the required controlling gauge is flashing, press the UP or DOWN key ( / ) to move to a different menu option.





4.5.4 Gauge calibration

If gauge 1 or gauge 2 is a type which supports remote calibration (for example APG-X or WRG) then the calibration options will be available. To calibrate gauge 1, select G1 and CAL LEDs together using the UP and DOWN keys ( / ), and then press the ENTER key (). The message "CAL'd" will be displayed for 3 seconds to show that the calibration command has been sent to the gauge. To calibrate gauge 2, first select G2 and CAL LED's.

Where an ASG is used, the calibration functions as a zero offset adjustment. You can cancel the calibration by pressing the ENTER key () again. The message "OFF" will be displayed to confirm that the offset adjustment has been removed.

Please refer to the instruction manual of the specific gauge which you are using for details of the correct calibration procedure.

4.5.5 Units selection

You can change the pressure units for the display by selecting the units menu option. When this option is selected, the numeric display will be blank, and the currently selected units will flash. To change the units, press the ENTER key (). The units enunciator will move between mbar, Torr and Pa with each press of ENTER. A further press of the ENTER key () will select voltage mode, when the LED enunciators will extinguish and '0.000' will flash on the display. Pressing ENTER key () again will return to mbar. When the required units are flashing, press the UP or DOWN keys ( / ) to move to a different menu option.

When the units are changed, the set-point values will be converted to the new units. For example, if a set-point threshold is entered as 1.0×10^{-3} mbar and the units are changed to Torr, then the value will be displayed as 7.5×10^{-4} Torr.

4.6 RS232 operation (enhanced only)



WARNING

The data received from this unit should not be used for safety purposes.

4.6.1 Message basics

The communications to the ADC work on a master / slave principle. The ADC is the slave and will only transmit a message in response to one sent to it. The master, a PC for example, must always start the conversation.

A conversation consists of a message to the ADC and its response back. Having sent a message to the ADC, wait for the reply before continuing. When the ADC receives a message a reply is always sent. If the message cannot be understood or if the syntax is wrong, an error message of the form "Err n" will be returned. Refer to [Appendix A](#) for a list of error numbers.

All messages consist of ASCII coded characters. Messages to the ADC start with either a "!" or a "?" character. All messages end with a carriage return (cr). Characters not enclosed by start (!?) and end (cr) characters will be ignored. Incomplete messages will be ignored if a new start character is received. Responses from the ADC end with a carriage return (cr).

There are two basic types of message sent to the ADC:

- Commands sending information to the ADC (starting with "!").
- Queries requesting information from the ADC (starting with "?").

4.6.2 Commands

Commands send information to the ADC. These can be literal commands such as 'turn gauge on' or values to be stored by the ADC such as 'set-point 1 high threshold'. A summary of available commands is shown in [Table 9](#). Full details of the commands are given in [Appendix B](#).

Table 9 - RS232 commands

Mnemonic	Meaning
!CH	Set-point high threshold
!CL	Set-point low threshold
!GA	Accept gauge error
!GW	Switch gauge on/off
!RC	Relay controlling gauge
!TH	Link high threshold
!TL	Link low threshold
!US	Units

4.6.3 Queries

Queries request information from the ADC. These can be direct queries of the value of a parameter such as gauge pressure, or reading a value currently stored in the ADC. A summary of available queries is shown in [Table 10](#). Full details of the queries and the corresponding response from the ADC are given in [Appendix C](#).

Table 10 - RS232 queries

Mnemonic	Meaning	Reply
?CH	Set-point high threshold	{pressure}
?CL	Set-point low threshold	{pressure}
?GA	Gauge pressure	{pressure}
?GV	Gauge version	{nn}
?RC	Relay controlling gauge	{1..2}
?TH	Link high threshold	{pressure}
?TL	Link low threshold	{pressure}
?US	Units	{0..3}
?VL	Voltage	{voltage}

4.6.4 Responses

Responses to commands will always be a message of the form "Errn". If the command syntax was correct the response will be "Err0", confirming that there is no error.

Responses to queries will usually be a string containing the requested data. If the syntax is not correct an error message of the form "Errn" will be returned. Refer to [Appendix A](#) for a list of error numbers.

4.7 Linking two ADCs (enhanced only)

4.7.1 Using two ADCs

Two ADCs may be linked together to allow automatic switching of one gauge by another, for example using an APG gauge to switch an AIM gauge on and off.

- Connect the controlling gauge (APG) to the Gauge 1 connector of the first ADC.
- Set the set-point 1 thresholds to the required pressures.
- Connect the controlled gauge (AIM) to the Gauge 1 connector of the second ADC.
- Connect the two Gauge 2 connectors of the two ADCs together using a standard Active Gauge cable.

The ADCs will automatically recognise the linking cable, and the AIM gauge on the second ADC will switch on and off at the pressures defined by the set point 1 thresholds of the first ADC.

4.7.2 Using one ADC

Two gauges may be linked together to allow automatic switching of one gauge by another.

- Connect a controlling gauge to the ADC. (APG, APG100 and APGX Gauges)
- Connect a controlled gauge to the ADC. (AIM-S and AIM-X Gauges)
- Set the link threshold on the link menu.

The ADC will automatically recognise the two gauges as being a controlling/controlled pair and switch the controlled gauge on and off at the pressures defined by the link thresholds.

The link thresholds default to above the operating range of controlling gauges, and will not trigger the controlled gauge to turn on or off until the link thresholds are set within the operating range of the controlling gauge.

The controlled gauge can be manually turned on or off within the "ON" range defined by the link thresholds. When the controlling gauge is above the high link threshold, manual operation of the controlled gauge is blocked until the controlling gauge drops below the low link threshold again.

5 MAINTENANCE

The ADC requires no regular maintenance. The unit is factory calibrated and will remain in calibration throughout its lifetime. Maintenance is limited to fault finding and software upgrades if required.

5.1 Safety



WARNING

Hazardous voltages are present inside the Controller. Qualified personnel only should carry out servicing.

5.2 Fault finding guide

Table 11 - Fault finding guide

Symptom	Possible cause	Remedy
Display blank (no LEDs lit)	Electrical supply defective	Check electrical supply cable and external fuses. Connect the electrical supply cable to any other device to confirm that the supply is good.
	Short circuit or overload on connections	Remove all connectors except the electrical supply and re-check. If display now lights, there is a fault in one of the external leads or devices. Re-connect one at a time until the fault is pinpointed.
	Internal fuse blown	Measure the voltage present between pins 1 and 2 of the RJ-45 gauge connector. This should be about 23V. If there is no voltage present then the internal fuse could be blown. This fuse is not replaceable and will only blow in the event of a major malfunction.
Display shows "ERR"	An error has been detected by the Controller or by a connected gauge	Refer to Appendix A for a description of error numbers. Press the ENTER key () to clear the message.
Display shows "???"	A gauge has not been recognised by the ADC	Check that the gauge is a type listed in Table 1 , and is supported by the ADC version which you have.
Unable to turn on AIM gauge	2 ADCs connected and Link blocking manual operation via comms	Adjust set-point 1 on controlling ADC above or within operating range of controlling gauge. See Section 4.5.2 .
	2 ADCs connected and Link set point set below operating range	
	Controlling and controlled gauges connected and Link Thresholds blocking manual operation or operation via comms	Adjust Link Thresholds above or within operating range of controlling gauge. See Section 4.5.2 . If problems persist then reset the ADC to Factory Defaults. See Section 4.2.1 .
	Controlling and controlled gauges connected and Link Thresholds set below operating range	

Table 11 - Fault finding guide (continued)

Symptom	Possible cause	Remedy
Chart recorder output voltage not as expected	Excessive loading on output	Set the ADC into voltage display mode (see Section 4.5.5) and compare the displayed voltage with the output voltage. If they are different then the loading may be incorrect. Check the connections and compare with the specification in Section 2.5.2.
Relays chattering	Insufficient hysteresis	Adjust the set-point low threshold lower or adjust the set-point high threshold higher. See Section 4.2.1.
RS232 no response	Cable wiring incorrect	Check that the wiring agrees with Figure 8 or 9.
	Protocol on master does not match ADC	Check that the master is set to 9600 baud, 8 data bits, 1 stop bit, and no parity.
	Handshaking selected at master	Check that no handshaking is selected. ADC does not support CTS/RTS and Xon/Xoff.
RS232 erratic	Message rate too fast	Ensure that the master is not sending more than 3 messages per second. Wait for reply from the ADC before sending another message.

5.3 Cleaning the controller

If necessary, use a soft dry cloth to clean the exterior of the Controller. Do not clean with harsh abrasives or liquids.

5.4 Software upgrade

As new compatible gauges are released, a software upgrade for the ADC might be necessary. If you have purchased a new gauge which is not listed in Table 1, and the display shows "???" when the gauge is connected, then you may need an upgrade. Please contact Edwards for details, quoting the serial number and the software version number of the ADC. The software version number is shown on the display during power-up, in the form "AdCxx".

5.5 Calibration service

A calibration service is available for all Edwards Controllers and gauges. If you require a calibration certificate for your ADC, please contact Edwards.

6 STORAGE AND DISPOSAL

6.1 Storage

Store the ADC in clean dry conditions in accordance with the technical specifications. Refer to [Section 2.2](#).

6.2 Disposal

Dispose of the Controller and any components safely in accordance with all local and national safety and environmental requirements.

Alternatively, you may be able to recycle the ADC and/or cables; contact Edwards or your supplier for advice (also see below).

The ADC and associated cables are within the scope of the European Directive on Waste Electrical and Electronic Equipment, 2002/96/EC. From August 2005, Edwards will offer European customers a recycling service for the ADC/cables at the end of the product's life. Contact Edwards for advice on how to return the ADC/cables for recycling.

The plastic enclosure of the ADC is made from >PPO+PS< material.



WARNING

Do not incinerate the Controller. If the Controller is heated to very high temperatures, dangerous gases may be emitted and internal components may explode.

This page has been intentionally left blank.

7 SPARES AND ACCESSORIES

7.1 Introduction

Edwards products, spares and accessories are available from Edwards companies in Belgium, Brazil, Canada, France, Germany, Hong Kong, Italy, Japan, Korea, Switzerland, United Kingdom, U.S.A. and a world-wide network of distributors. The majority of these centres employ Service Engineers who have undergone comprehensive Edwards training courses.

Order spare parts and accessories from your nearest Edwards company or distributor. When you order, please state for each part required:

- Model and Item Number of your equipment
- Serial number (if any)
- Item Number and description of the part.

7.2 Accessories

Table 12 shows the range of accessories that can be purchased.

Table 12 - Accessories

Product Description	Ordering Information
Active Digital Controllers Active Digital Controllers - Standard version Active Digital Controllers - Enhanced version	D395-90-000 D395-91-500
Gauges APG100-XM, APG100-XLC Ranges APG-L, APG-M, APG-MP Ranges APGX-L, APGX-M, APGX-MP, APGX-H Ranges AIM-S, AIM-SL, AIM-X, AIM-XL Ranges WRG-S and WRG-SL ASG	
Active Gauge Cables (including RJ45 connectors at both ends) 0.5 m active gauge cable 1 m active gauge cable 3 m active gauge cable 5 m active gauge cable 10 m active gauge cable 15 m active gauge cable 25 m active gauge cable 50 m active gauge cable 100 m active gauge cable	D400-01-005 D400-01-010 D400-01-030 D400-01-050 D400-01-100 D400-01-150 D400-01-250 D400-01-500 D400-01-999
Interface cable 2 m RS232 interface cable	D397-00-834
Mains cables 2 m UK plug 2 m USA plug 2 m Northern European plug	D400-13-025 D400-13-120 D400-13-030

This page has been intentionally left blank.

Appendix A Error Numbers

The table below lists all ADC error numbers, together with likely causes and suggested remedies. The error numbers apply both to errors appearing on the display and to error messages sent over the RS232 link.

Table A1 - ADC error numbers

ERR number	Meaning	Possible cause / remedy
Controller errors		
0	No error	RS232 message in response to a correctly formatted command, indicating no error.
1	EEPROM error	The internal EEPROM checksum has failed. Some stored values such as set-point thresholds will revert to the factory default.
2	ID reference error	The reference used for identifying gauges is incorrect. Please remove all gauge connection, turn the electrical supply off and on, and wait for 30 seconds before connecting gauges.
Gauge errors		
11	Gauge voltage too high	The voltage from a gauge is too high. The gauge may be defective.
12	Gauge voltage too low	The voltage from a gauge is too low. The gauge may be defective.
13	AIM Gauge not striking	The voltage from a gauge is too low. The gauge may be defective.
21	WRG Pirani failure	Errors specific to WRG. Please refer to the WRG manual for details.
22	WRG magnetron short	
23	WRG striker fail	
24	WRG magnetron not struck	
25	APGX filament failure	Errors specific to APGX. Please refer to the APGX manual for details.
26	APGX cal err	
27	APGXH tube not fitted	
RS232 errors		
51	Not a valid query or command word	The ADC did not recognise the mnemonic in a message. Check that the message is as specified in Appendix B and Appendix C .
52	Message incomplete	The mnemonic was recognised but additional characters were expected. Check that a command (!) was not used in place of a query (?).
53	Message too long	The mnemonic was recognised by had extra characters at end of message. Check format of command message in Appendix B .
54	Incorrect gauge number	Queries and commands are only valid for gauges 1 and 2.
57	Incorrect number format	A command had an invalid number. Check range of valid numbers in Appendix B .

Table A1 - ADC error numbers (continued)

ERR number	Meaning	Possible cause / remedy
58	Incorrect pressure format	A command had a wrongly formatted pressure. Check format specified in Appendix B .
81	No gauge connected	An attempt was made to read or control a gauge when it was not connected. Check that gauge number is correct.
82	Unknown gauge type	A gauge is connected that cannot be recognised. Check that the gauge is a type listed in Table 1 . If not, a software upgrade may be needed. See Section 5.4 .
83	Gauge not reading pressure	An attempt was made to read a gauge which was switched off. Check that the gauge is switched on. Use the command !GW if necessary.
84	AIM gauge striking	An attempt was made to read a gauge which was striking. Wait until the gauge has struck and try again.
90	Incorrect gauge type, query/command not appropriate	The command or query is not supported by the particular gauge e.g. an attempt was made to switch an APG on or off.
91	Gauge turn-on is inhibited by link	A "GW1=1" command has been sent when 2 ADCs are linked, and the pressure is too high to allow the controlled gauge to turn on.

Appendix B RS232 Commands

In the lists that follow:

x refers to gauge channel and is in the range 1..2

y refers to a single digit number

pressure is in exponential format which must be m.mEsee where m is the mantissa with 1 decimal place, s the sign (+ or -) and e is the exponent (2 digits).

!CH x=pressure

Set the set-point high threshold for relay **x** as a pressure using the currently selected units. If you set the threshold to a pressure which cannot be measured by the gauge which you are using then the set point will not operate.

Example: !CH2=1.3E-03

!CL x=pressure

Set the set-point low threshold for relay **x** as a pressure using the currently selected units. If you set the threshold to a pressure which cannot be measured by the gauge which you are using then the set point will not operate.

Example: !CL1=1.0E+01

!GA x

Accept an error being reported for the gauge channel **x**. This is equivalent to pressing the ENTER key (↵) on the front panel to clear an error message. If the error originated in a gauge it may be necessary to disconnect the gauge and correct the fault before the error message can be cleared.

Example: !GA1

!GW x=y

Turn the gauge on channel **x** to on or off. If the gauge type cannot be switched on and off (for example APG), then an error message is returned. The value of **y** is 0 = off, 1 = on.

Example: !GW2=1

!RCx=y

Set relay control for relay **x** to gauge **y**. Only relay 2 can be configured, any other value will produce an error message. The set-point thresholds for relay 2 are configured using !CH2 and !CL2 even if the relay is controlled by gauge 1.

Example: !RC2=1

!TH=pressure

Set the link high threshold as a pressure using the currently selected units. If you set the threshold to a pressure which cannot be measured by the gauge which you are using then the link will not operate.

Example: !TH=1.3E03

!TL=pressure

Set the link low threshold as a pressure using the currently selected units. If you set the threshold to a pressure which cannot be measured by the gauge which you are using then the link will not operate.

Example: !TL=1.0E-03

!USy

Set the pressure units. The value of **y** is:

0 = volts

1 = mbar

2 = Pa

3 = Torr

Example: !US2

This page has been intentionally left blank.

Appendix C RS232 Queries

In the lists that follow:

x refers to gauge channel and is in the range 1..2
pressure is in exponential format m.mmEsee where m is the mantissa,
s the sign (+ or -) and e is the exponent (2 digits).

?CH x

Returns the set point high threshold for relay x as a pressure in the currently selected units.

Example: ?CH1
Reply: 5.50E-03

?CL x

Returns low set point the threshold for relay x as a pressure in the currently selected units.

Example: ?CL2
Reply: 1.00E+02

?GA x

Returns the current pressure reading for gauge channel x. If the current units are volts then the voltage will be returned. If the gauge is switched off or has an error then an error number will be returned. Refer to [Appendix A](#) for a description of error numbers.

Example: ?GA1
Reply: 3.20E-05

?GV x

Returns the gauge version for channel x, as a number. The number is the same as the ID number indicated on the display when a gauge is first connected.

Example: ?GV1
Reply: 00 = No gauge
04 = APG-M
05 = APG-L
06 = APGX-H
11 = AIM-S
15 = ASG
19 = AIM-X
20 = WRG
21 = APGX-M / APGX-L

?RCx

Returns the gauge number currently assigned to relay x. Only relay 2 can be configured, any other value will produce an error message.

Example: ?RC2
Reply: 1

?TH

Returns the link high threshold as a pressure in the currently selected units.

Example: ?TH
Reply: 1.3E-03

?TL

Returns the link low threshold as a pressure in the currently selected units.

Example: ?TL
Reply: 1.0E-03

?US

Returns the current units setting.

Example:

?US

Reply:

0 = volts

1 = mbar

2 = Pascal

3 = Torr

?VL x

Returns the gauge voltage reading for channel x as a number of the form vv.vvv

Example:

?VL2

Reply:

5.324

Index

A	
Accessories	21
Active gauge connectors	4
ADC error numbers	23
Analogue / relay connector (enhanced only)	5
Appendix A	23
Appendix B	25
Appendix C	27
B	
Bench mounted dimensions (mm)	7
Bench-top mounting	7
C	
Calibration service	18
Checklist of components	7
Cleaning the controller	18
Commands	15
Compatible gauges for the ADC	1
Component checklist	7
Connecting active gauges	9
Connecting the analogue / relay connector (enhanced only)	10
Connecting the electrical supply	9
Connecting the serial interface (enhanced only) ..	10
Connections	4
D	
Dimensions of a bench mounted TIC (mm)	7
Display	3
Disposal	19
E	
Electrical data	3
Error Numbers	23
F	
Fault finding guide	17
Fitting the controller	7
Front panel description	11
Front panel display	11
Front panel symbols and their functions	11
Fuse	3
G	
Gauge	4
Gauge calibration	14
Gauge connector pin-out	4
Gauge display (standard)	12
Gauge ID numbers	12
Gauge identification	12
Gauge pressure display	13
I	
IBM PC RS232 interface - 9-way	10
Installation	7
Introduction	1, 21
L	
Linking two ADCs (enhanced only)	16
M	
Maintenance	17
Mechanical data	3
Menu items	13
Menu structure (enhanced)	13
Message basics	15
O	
Operating and storage data	3
Operation	11
P	
Panel cut-out required	8
Panel mounting	8
Panel mounting the ADC	8
Pin connections and pin-out for the analogue / relay connector	5
Pin connections for an 8-way FCC/RJ45	4
Pin connections for the serial comms connector ..	6
Power up	11
Product description	1
Pump set up	14
Q	
Queries	15
R	
Rear panel connections	9
Rear panel description	9
Responses	16
RS232 commands	15, 25
RS232 operation (Enhanced only)	15
RS232 queries	16, 27
S	
Safety	17
Scope and definitions	1
Serial communications (enhanced only)	6
Set-point 2 controlling gauge	14
Set-point adjustment	13
Set-point an link threshold adjustment	13
Software upgrade	18
Spares and accessories	21
Storage	19
Storage and disposal	19
T	
Technical data	3
U	
Units selection	14
Unpack and inspect	7
Using analogue outputs	10
Using relays	10
Using two ADCs	16

